

10. TROUBLESHOOTING

Trouble	Possible Origin(s)	Remedy(s)
Alarm trigger becomes erratic in bad weather.	Lenses out of alignment.	Check overall system installation. If still erratic, realign the lenses.
Frequent false triggers from leaves, bird, etc.	a. Too sensitive. b. Bad location.	a. Reduce the response time. b. Change the transmitter and/or location.

11. SPECIFICATIONS

Model	Quad-50CS	Quad-100CS	Quad-150CS	Quad-200CS
Max. range(outdoor)	165'(50m)	330'(100m)	495'(150m)	660'(200m)
Max. range(indoor)	330'(100m)	660'(200m)	990'(300m)	1320'(400m)
Current (Tx+Rx)	110mA	115mA	120mA	125mA
Current (Tx+Rx+Heaters)	260mA	270mA	280mA	290mA
Power	AC/DC 12~24V (Non-polarity)			
Detection system	50~700msec(variable)			
Alarm output	Contact capacity:NC./NO. 1A/120VAC			
Tamper output (Tx & Rx)	NC switch, 1A@120VAC			
Signal LED (Receiver)	Yellow LED - OFF: Beam aligned properly. - ON: Beam broken or beam alignment not proper.			
Power LED (Receiver and Transmitter)	Green LED - ON: Indicates connected to power.			
Laser wavelength	650nm			
Laser output power	≤5mW			
Alignment angle	Horizontal: ±90°, Vertical: ±15°			
Operating temperature	-13°F(-25°C) to +131°F(+55°C)			
Weight	5.73lbs.(2.6kg)			
Case	PC Resin			
Humidity	<70%			
Dimensions	387(H)×113(W)×110(D) m/m			

12. EXTERNAL DIMENSIONS

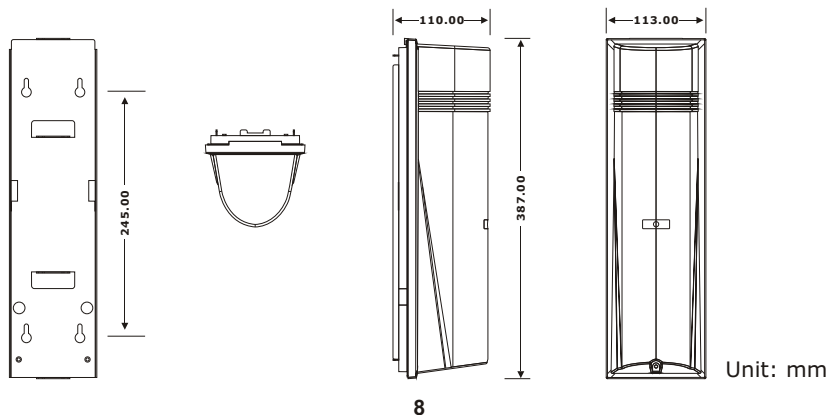

Multi-Frequency (4 Channels Selectable) Quad Beams

Quad-50CS / Quad-100CS / Quad-150CS / Quad-200CS

Features: range —

- Quad-50CS: Outdoor 165ft.(50m), Indoor 330ft.(100m) (With laser)
- Quad-100CS: Outdoor 330ft.(100m), Indoor 660ft.(200m) (With laser)
- Quad-150CS: Outdoor 495ft.(150m), Indoor 990ft.(300m) (With laser)
- Quad-200CS: Outdoor 660ft.(200m), Indoor 1320ft.(400m) (With laser)



INSTALLATION MANUAL

- Laser beam alignment function (optional)
- Buzzer sound (beep sound) for beam alignment.
- Led indicators for beam strength. (5 Leds)
- Environment module: the environmental signal is initiated if the beam reception level is reduced by approx 50% or more, The module "watches" for a gradual degradation of the beam reception which is indicative of extremely poor weather conditions. N.C. or N.O. signal output is selectable.
- Beam alignment volt. testing points
- Multi frequency (4 channels selectable)
- Quad beams
- Heater (optional)
- Programmed A.G.C.
- Input Volt.: AC/DC 12-24V
- IP-55 ingress protection
- Sensing range (outdoors): 50m/100m/150m/200m
- Size: 387(H)×113(W)×110(D) m/m

1. PARTS DESCRIPTION

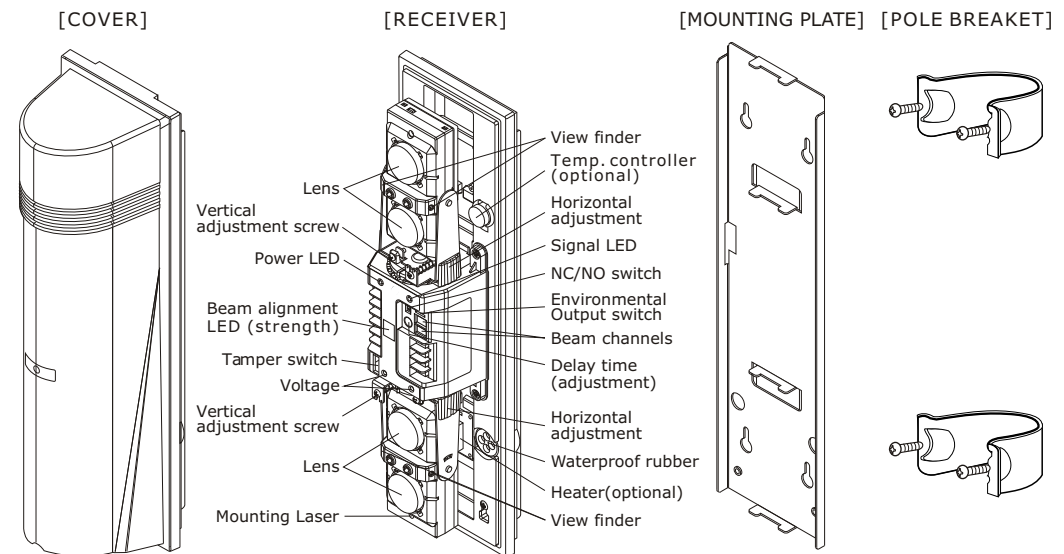

2. FOUR CHANNEL FREQUENCY SELECTION

The beam pairs may be set at various frequency levels to avoid crosstalk between units which are stacked, in-line, or other configurations which have the potential of spill-over transmission from one beam to another. Set the frequency level as illustrated.

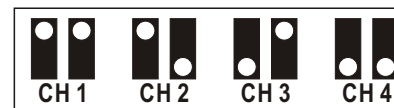

MAKE SURE THE TRANSMITTER AND THE RECEIVER OF THE PAIR ARE SET AT THE SAME CHANNEL!

Paired TR/RE will not set up unless set at the same channel.

3.COMBINATION OF ACTUAL INSTALLATION

1) Linear protection:

beams can be installed in a horizontal stack configuration, for ultimate security in most situations

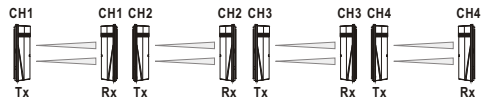

2) Quad -stacked protection

beams can be installed in a vertical stack configuration, for ultimate security in most situations

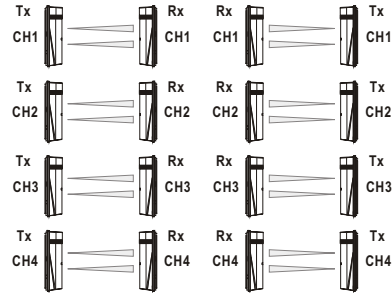

3) Multi -stacked linear protection <MAX.: 8 units>

beams can be installed in any combination of vertical and horizontal stack configuration for ultimate security in all situations

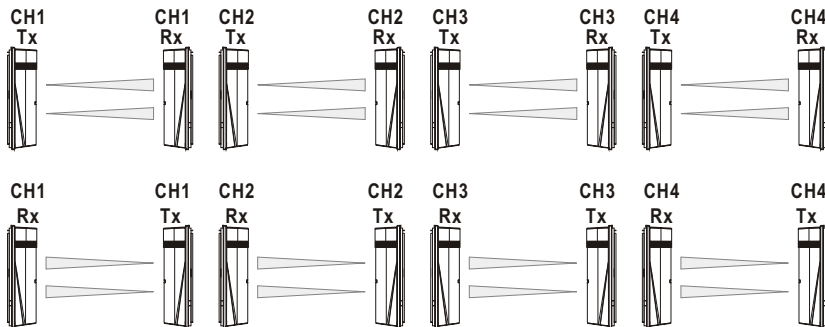

4) Perimeter protection

installation of the beams at the corners of a square-shaped area for the ultimate in perimeter security

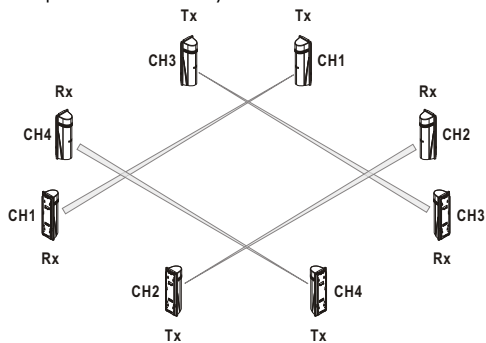

5) Perimeter double--stacked protection

installation of the beams at the corners of a square-shaped area, but in a double-stacked vertical configuration for the ultimate in perimeter security at any height

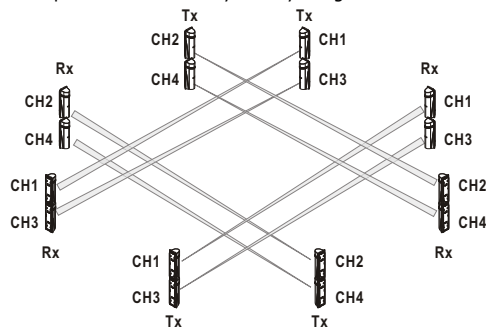

© The use of a voltmeter for alignment is advised, in order to ensure highest level of stability.

© Upper and lower beams should be the same model type in stacked configurations.

Laser adjustment

- (1) Remove the transmitter cover, then turn the laser on with the ON/OFF switch.
- (2) Adjust the transmitter's sensor unit vertically and horizontally until the red dot is centered on the receiver and both the receiver's LEDs turn off.
- (3) Repeat steps 1 and 2 for the receiver.
- (4) Turn the lasers off, and then replace the covers.



WARNING: Do not look directly at the lasers.

Fine Tuning the Receiver

- (1) Once the sensor is mounted and aligned, the sensor can be fine tuned using the voltage output jack.
- (2) Set the range of a volt-ohm meter (VOM) to 0~10VDC.
- (3) Measure the voltage.
- (4) Adjust the horizontal angle by hand until the VOM indicates the highest voltage.
- (5) Adjust the vertical angle by turning the vertical adjustment screw until the VOM indicates the highest voltage.

Alignment quality	Voltage output
Strongest	>2V
Good	1.7~2.0V
Ok	1.4~1.7V
Poor	1.1~1.4V
Bad	<1.1V
No Signal	0V

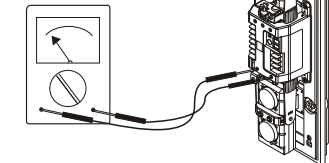

8.RESPONSE TIME

Adjust response time as follows. The unit does not detect the passing object faster than the response time set. If the response time is set longer, the unit does not detect human beings. Adjust to a little longer response time in a site where large passing objects, newspaper or carton box may move.

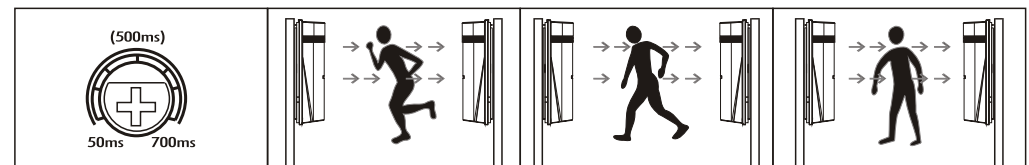

9.TROUBLESHOOTING

Trouble	Possible Origin(s)	Remedy(s)
Transmitter LED does not light.	Incorrectly wired and/or insufficient voltage	Ensure the power supply to the transmitter is 10 to 30 VDC.
Receiver LED never lights up when the beam is interrupted.	a. Insufficient voltage b. Beam reflected away from receiver c. Beams not simultaneously interrupted.	a. Double-check the voltage. b. Clean the cover. c. Check overall installation.
Beams interrupted and LED lights, but no alarm trigger.	Alarm trigger cable may be cut, or the relay contact stuck due to overloading.	Check the continuity of the wiring between the sensor and the alarm.
Alarm LED continuously lit.	a. Lenses out of alignment. b. Beam are blocked. c. Cover is foggy or dirty.	a. Realign the lenses. b. Remove any obstacles. c. Clean the cover.

6. INSTALLATION METHOD

Wall Mount

- (1) Loosen the cover locking screw and remove the cover. Loosen the unit setting screw at lower part of unit base. Slide the mounting plate downwards and remove it.

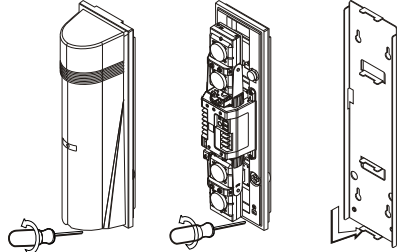

- (2) Pull wire through on the installation site.
- (3) Break grommet on mounting plate and pull wire through it. Secure the plate with 4mm screws.

Note: Plug opening between grommet and wire with sealing materials.

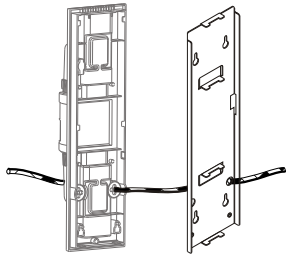

Pull wire through sensor body (back to front) and attach it to the mounting plate.

- (4) When exposed wired break knockouts (2 positions) on the rear of unit, pull wire through as the figure and attach it to the mounting plate.

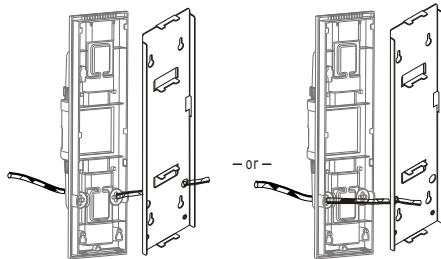

- (5) After wiring is completed, adjust alignment, check operation and attach cover.

Pole Mount

- (1) Use dia 38mm to 45mm pole.
- (2) Insert 2 pcs. of oval countersunk head screws (M4x20) in a pole bracket with a few rotation.
- (3) Fix pole mounting plate to pole with pole bracket.
- (4) Detach cover, and remove mounting plate from sensor body.
- (5) Temporarily insert 2 pcs of M4x10 screws in pole mounting plate and fix sensor, mounting plate on them.
- (6) Do the same procedure as (3)-(5) of wall mount.

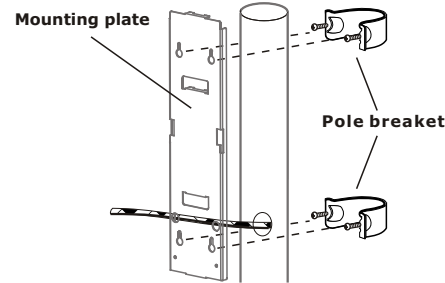

7. ALIGNMENT AND OPERATION

Eyeball adjustment

- (1) Remove the transmitter cover, and look into one of the alignment viewfinders (one of the four holes located between two lenses) at a 45° angle.
- (2) Adjust the horizontal angle of the lens vertically and horizontally until the receiver is clearly seen in the viewfinder.
- (3) Repeat steps 1 and 2 for the receiver.
- (4) Replace the transmitter and receiver covers.

NOTE: If you cannot see the opposite unit in the viewfinder, put a sheet of white paper near the unit to be seen.

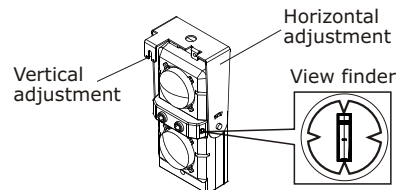

4. CAUTIONS ON INSTALLATION

Do Not

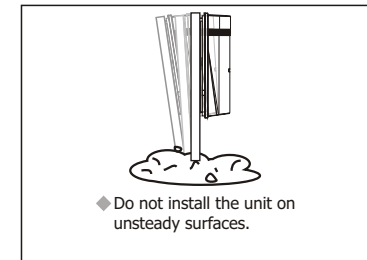
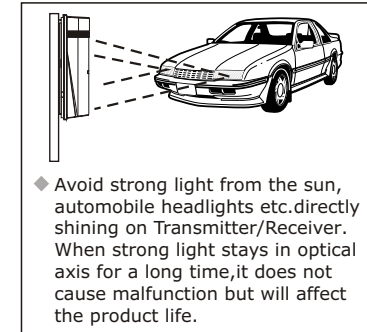
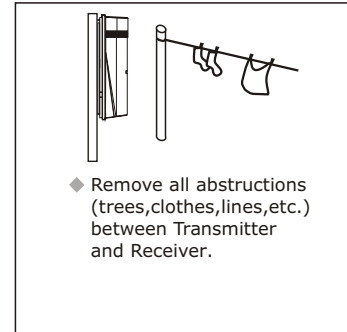

Expansion of beam

The protection distance (between Transmitter/Receiver) should be placed in the rated range.

Model	Detection distance	Spread of beam
Quad-50CS	50m (165 ft.)	1.5m (4.9 ft.)
Quad-100CS	100m (330 ft.)	3.0m (9.8 ft.)
Quad-150CS	150m (495 ft.)	4.5m (14.8 ft.)
Quad-200CS	200m (660 ft.)	6.0m (19.7 ft.)

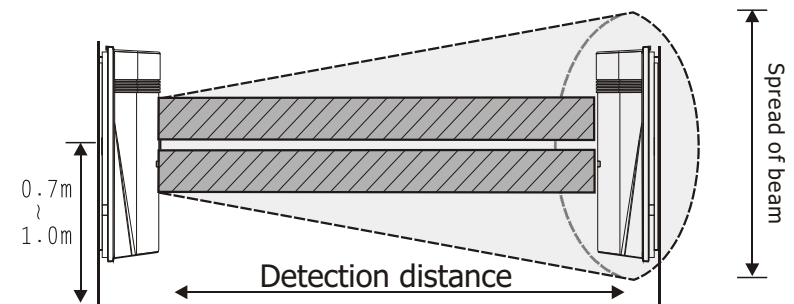

Position of installation

The photoelectric beam lens can be adjusted horizontally $\pm 90^\circ$, and vertically $\pm 15^\circ$. This allows much flexibility in terms of how the transmitter and receiver can be mounted. Install at a distance of 32" to 39" (80 to 100cm) above the ground for most situations.

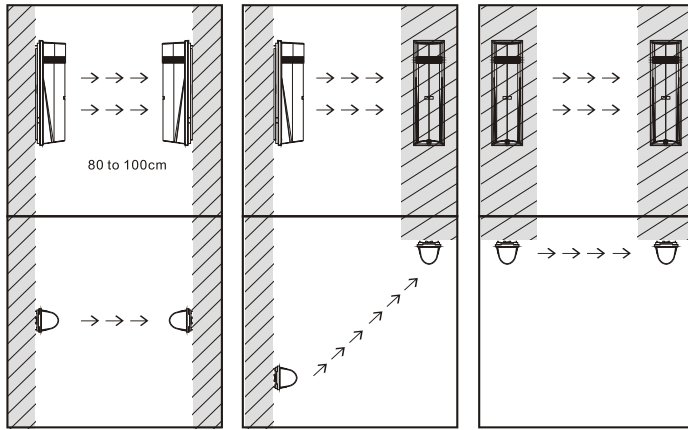
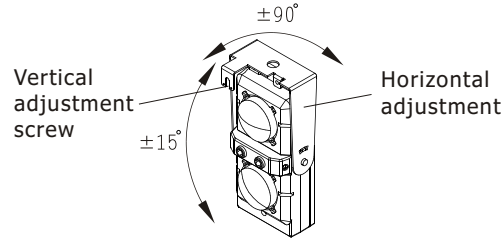

5. WIRING

Wiring

TX

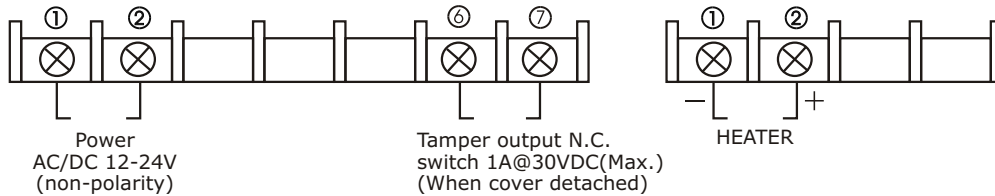

RX

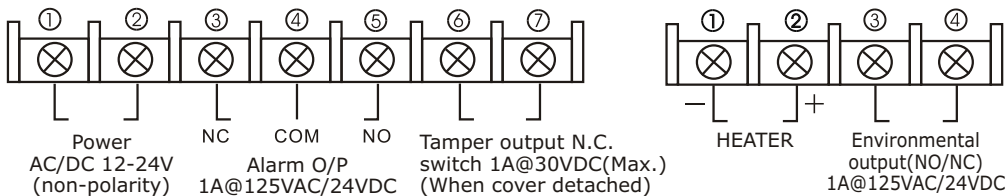

Running the Cable

Run a cable from the alarm control panel to the photobeam sensor. If burying the cable is required, make sure to use electrical conduit. Shielded cables are strongly suggested. See table 1 for maximum cable length.

Table 1: Cable Length

Model No.	Quad-50CS		Quad-100CS		Quad-150CS		Quad-200CS	
	12V	24V	12V	24V	12V	24V	12V	24V
AWG22	320m	2,800m	280m	2,400m	200m	1,600m	110m	900m
AWG20	550m	4,800m	450m	4,200m	350m	3,000m	170m	1,400m
AWG18	800m	7,200m	700m	6,200m	500m	4,200m	250m	2,200m
AWG16	980m	8,800m	850m	7,600m	590m	5,200m	310m	2,600m

Note(1): Max. cable length when two or more sets are connected is the value shown in Table 1 divided by the number of sets.

Note(2): The power line be wired to a distance of up to 3,300 ft. (1,000m) with AWG22(0.33mm) telephone wire.

Connection

Example connection 1 - Standard

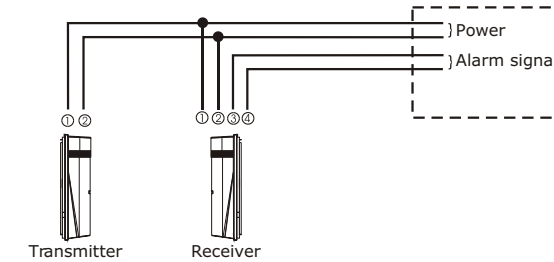

Example connection 2 - In-line Single Channel

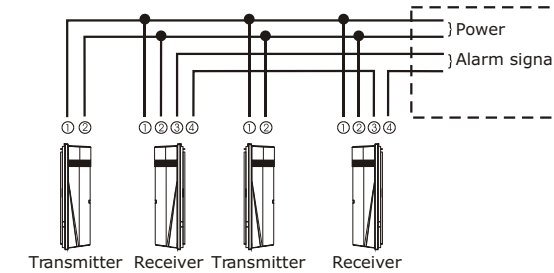

Example connection 2 - Dual Sensors, Separate Channels

